

# Building and Simulating Models using Copasi

Vijayalakshmi Chelliah  
*WTAC: In Silico Systems Biology*  
*EMBL-EBI, Hinxton, UK*  
*April, 2012*

Files and supporting materials are available at:  
[http://www.ebi.ac.uk/~viji/BIOMD-tutorials/WTAC\\_25April2012/](http://www.ebi.ac.uk/~viji/BIOMD-tutorials/WTAC_25April2012/)



- ❑ Mitogen activated protein kinase (MAPK) cascades are ubiquitous signalling modules that couple receptor mediated events at the cell surface to cytoplasmic and nuclear effectors.
- ❑ MAPK signalling cascades – signal-relay mechanism involves sequential phosphorylation of three kinases (Ser/Thr protein kinases).
- ❑ Involved in many cellular processes such as cell proliferation, differentiation, movement, survival etc.). Widely conserved among eukaryotes.
- ❑ The cascade arrangement has important consequences for the dynamics (like switch or all-or-none and oscillatory activation pattern) of MAPK signaling

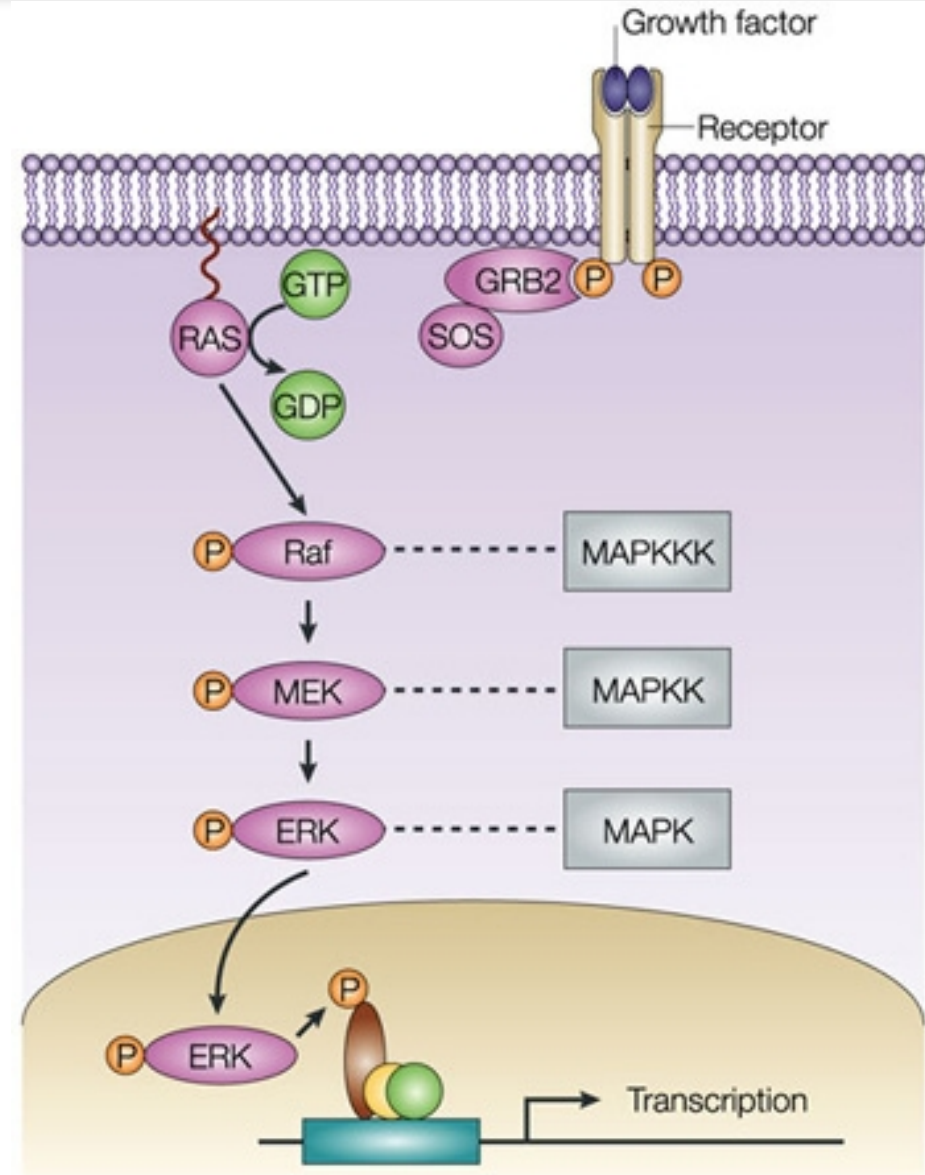

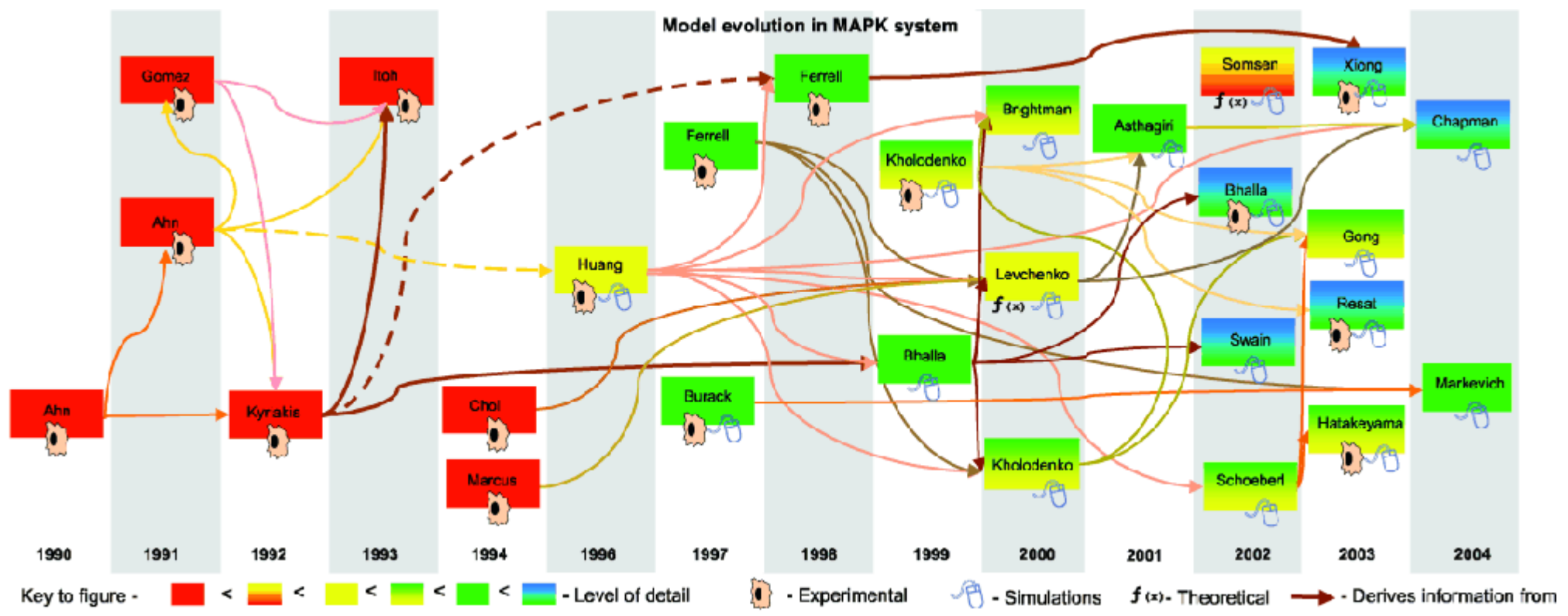

Vayttaden et al. 2004



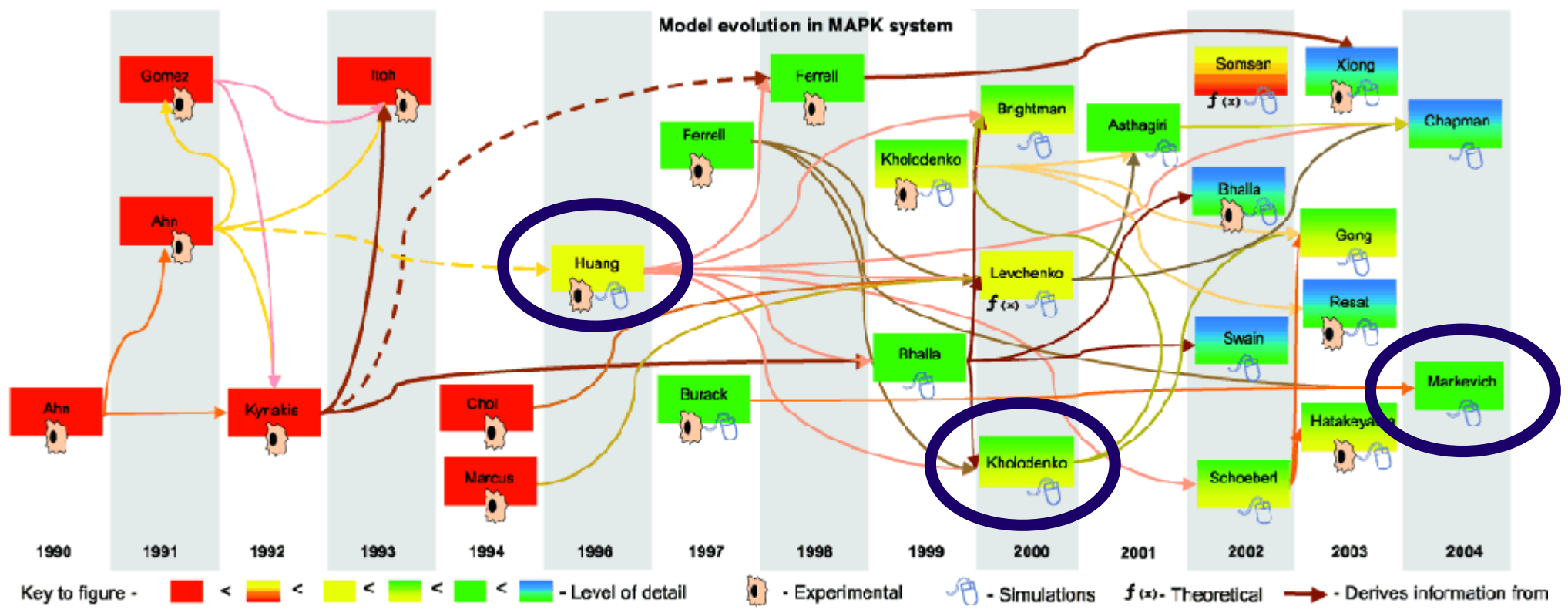

Vayttaden et al. 2004



*Proc. Natl. Acad. Sci. USA*  
Vol. 93, pp. 10078–10083, September 1996  
Biochemistry

## Ultrasensitivity in the mitogen-activated protein kinase cascade

CHI-YING F. HUANG AND JAMES E. FERRELL, JR.<sup>†</sup>

Department of Molecular Pharmacology, Stanford University School of Medicine, Stanford, CA 94305-5332

Communicated by Daniel E. Koshland, Jr., University of California, Berkeley, CA, May 16, 1996 (received for review January 22, 1996)

**ABSTRACT** The mitogen-activated protein kinase (MAPK) cascade is a highly conserved series of three protein kinases implicated in diverse biological processes. Here we demonstrate that the cascade arrangement has unexpected consequences for the dynamics of MAPK signaling. We solved the rate equations for the cascade numerically and found that MAPK is predicted to behave like a highly cooperative enzyme, even though it was not assumed that any of the enzymes in the cascade were regulated cooperatively. Measurements of MAPK activation in *Xenopus* oocyte extracts confirmed this prediction. The stimulus/response curve of the MAPK was found to be as steep as that of a cooperative enzyme with a Hill coefficient of 4–5, well in excess of that of the classical allosteric protein hemoglobin. The shape of the MAPK stimulus/response curve may make the cascade particularly appropriate for mediating processes like mitogenesis, cell fate induction, and oocyte maturation, where a cell switches from one discrete state to another.

Although the biological responses associated with mitogen-activated protein kinase (MAPK) signaling are highly varied, the basic structure of the MAPK cascade is well conserved (1–3). The cascade always consists of a MAPK kinase kinase (MAPKKK), a MAPK kinase (MAPKK), and a MAPK. MAPKKKs activate MAPKKs by phosphorylation at two conserved serine residues and MAPKKs activate MAPKs by phosphorylation at conserved threonine and tyrosine residues (Fig. 1). The cascade relays signals from the plasma membrane

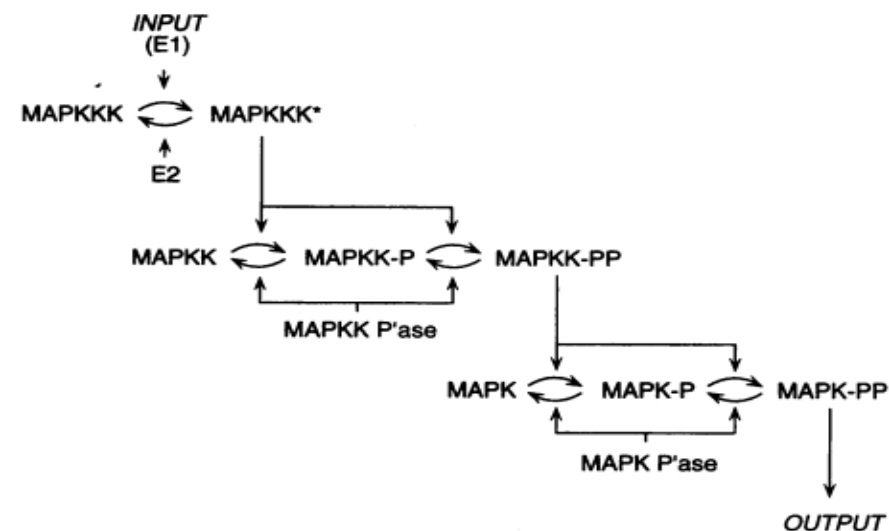
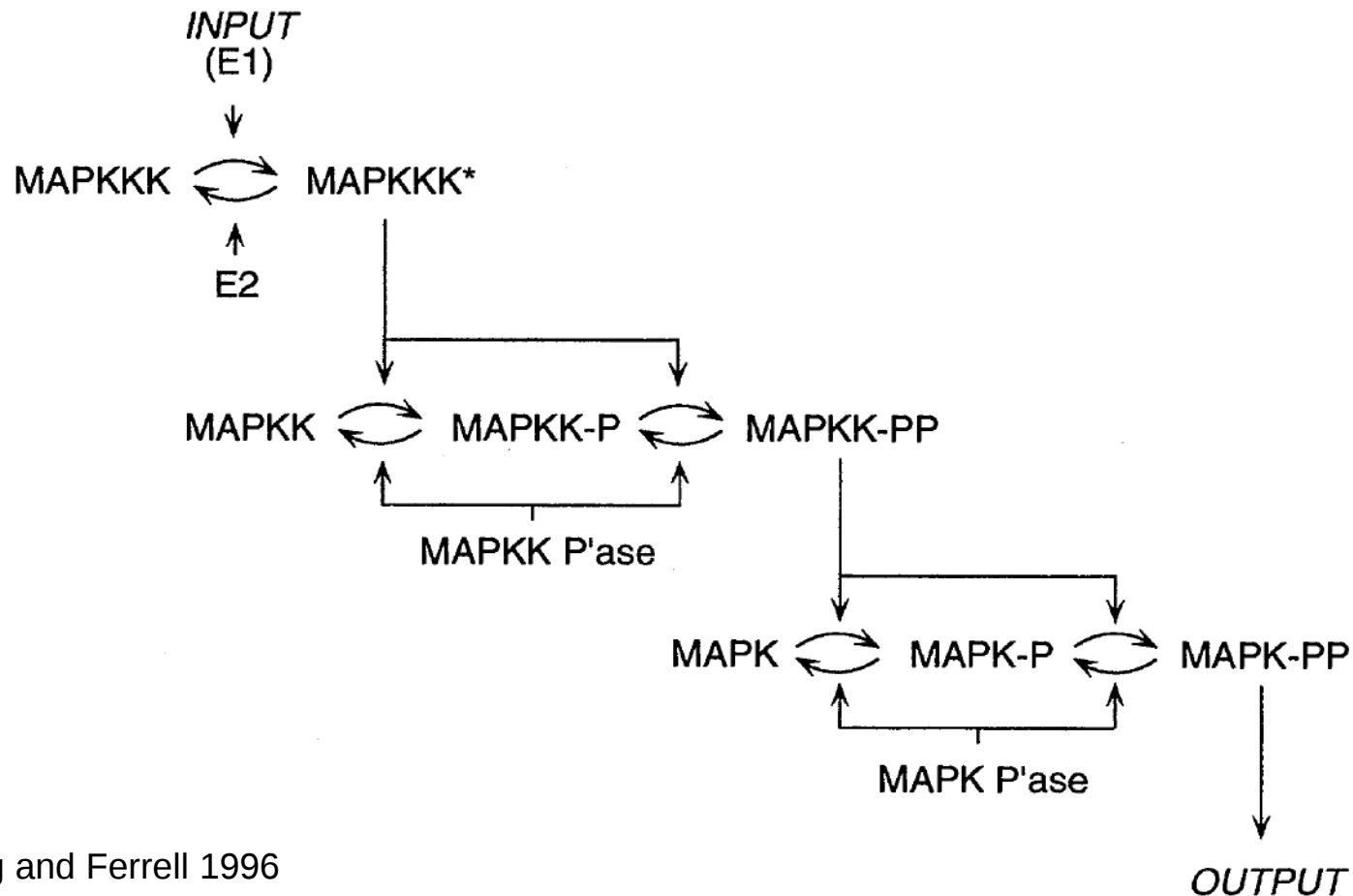

FIG. 1. Schematic view of the MAPK cascade. Activation of MAPK depends upon the phosphorylation of two conserved sites [Thr-183 and Tyr-185 in rat p42 MAPK/Erk2 (4, 5)]. Full activation of MAPKK also requires phosphorylation of two sites [Ser-218 and Ser-222 in mouse Mek-1/MKK1 (6–10)]. Detailed mechanisms for the activation of various MAPKKKs (e.g., Raf-1, B-Raf, Mos) are not yet established; here we assume that MAPKKKs are activated and inactivated by enzymes we denote E1 and E2. MAPKKK\* denotes activated MAPKKK. MAPKK-P and MAPKK-PP denote singly and doubly phosphorylated MAPKK, respectively. MAPK-P and MAPK-PP denote singly and doubly phosphorylated MAPK. P'ase denotes phosphatase.

- the cascade was modelled as a simple linear chain of subsequent phosphorylations and dephosphorylations
- mass action kinetics were employed for reactions and complex formations
- the parameters and concentrations were only roughly estimated from experimental results



Huang and Ferrell 1996



a term coined by Goldbeter and Koshland for response curves steeper than a pure Michaelis-Menten curve => dependence of output on signal strength greater than just linear, giving an S-shaped or sigmoid response curve

an enzyme showing a typical Michaelis-Menten behaviour requires an 81 fold increase of substrate/signal to go from 10% to 90% maximal activity/response

- more noise resistant
- can convert a graduated signal into an all or nothing response = buzzer/switch like behaviour
- can be compared to Hill functions ( $out = s^h / (K^h + s^h)$ ) in which  $h > 1$  indicates ultrasensitivity

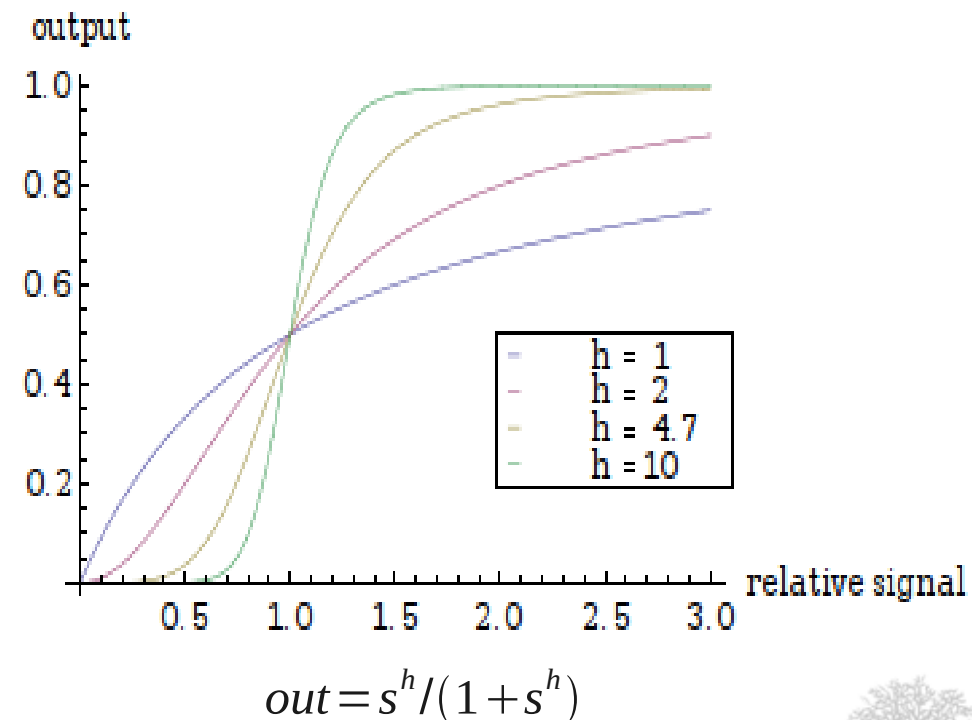
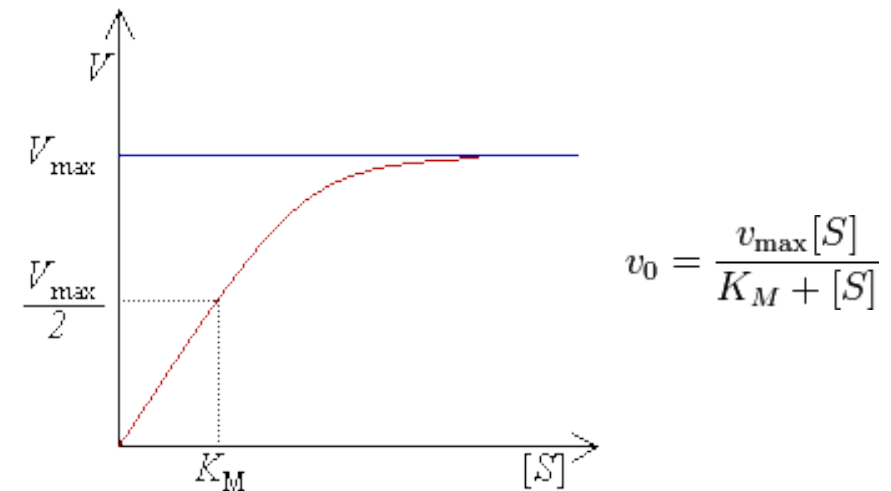

## Results:

- the model of the MAPkinase cascade can show ultrasensitivity of the output to the input strength, although each of its levels in isolation displays sensitivity similar to the MM curve
- the experimental results in *Xenopus laevis* oocytes is roughly reproduced with the model

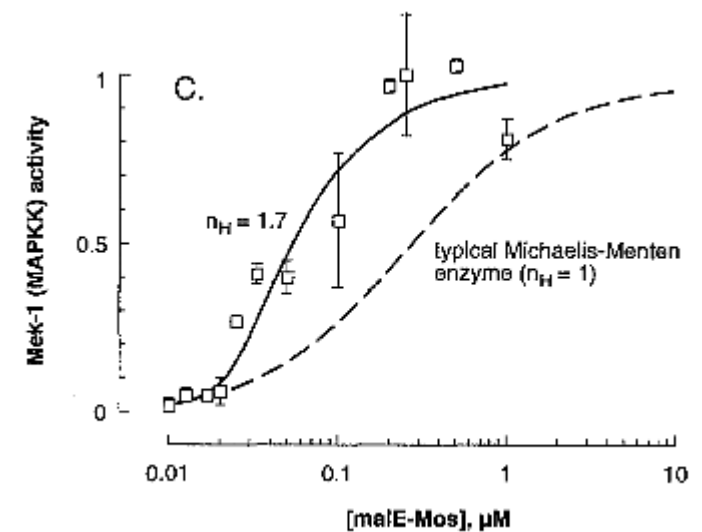
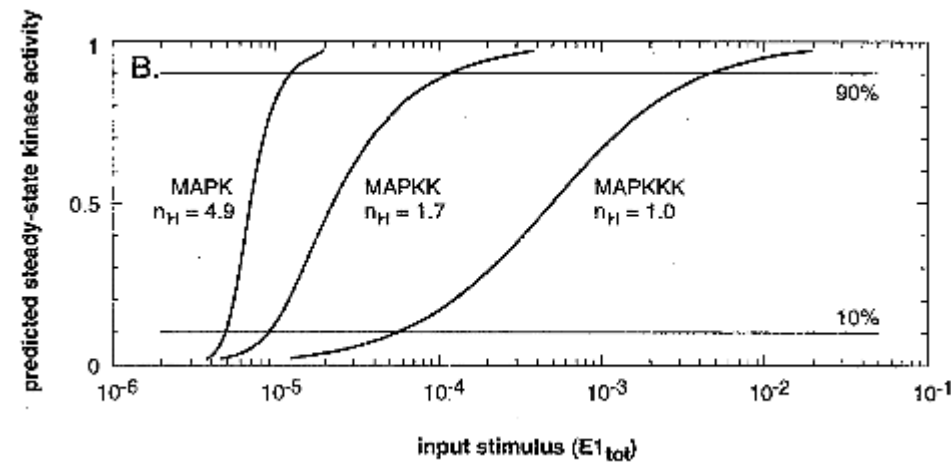
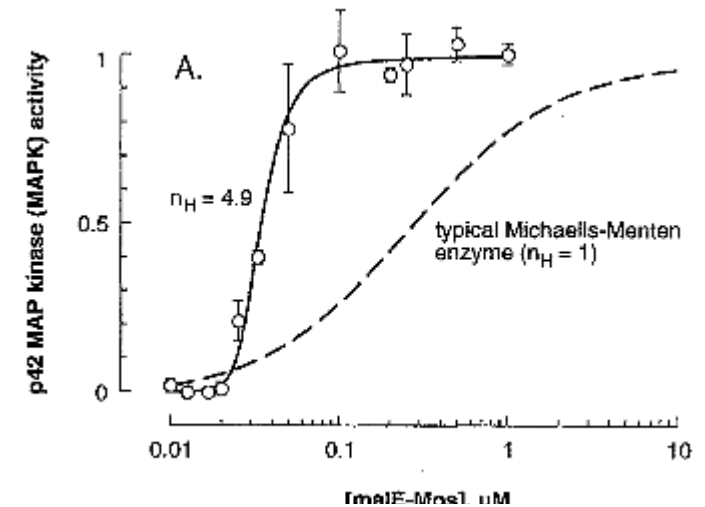



*Eur. J. Biochem.* **267**, 1583–1588 (2000) © FEBS 2000

## Negative feedback and ultrasensitivity can bring about oscillations in the mitogen-activated protein kinase cascades

**Boris N. Kholodenko**

*Department of Pathology, Anatomy and Cell Biology, Thomas Jefferson University, Philadelphia, PA, USA*

Functional organization of signal transduction into protein phosphorylation cascades, such as the mitogen-activated protein kinase (MAPK) cascades, greatly enhances the sensitivity of cellular targets to external stimuli. The sensitivity increases multiplicatively with the number of cascade levels, so that a tiny change in a stimulus results in a large change in the response, the phenomenon referred to as ultrasensitivity. In a variety of cell types, the MAPK cascades are imbedded in long feedback loops, positive or negative, depending on whether the terminal kinase stimulates or inhibits the activation of the initial level. Here we demonstrate that a negative feedback loop combined with intrinsic ultrasensitivity of the MAPK cascade can bring about sustained oscillations in MAPK phosphorylation. Based on recent kinetic data on the MAPK cascades, we predict that the period of oscillations can range from minutes to hours. The phosphorylation level can vary between the base level and almost 100% of the total protein. The oscillations of the phosphorylation cascades and slow protein diffusion in the cytoplasm can lead to intracellular waves of phospho-proteins.



- the cascade was modelled as a simple linear chain of subsequent phosphorylations and dephosphorylations with a negative feed back loop
- Michaelis Menten kinetics were assumed for kinase and phosphatase reactions

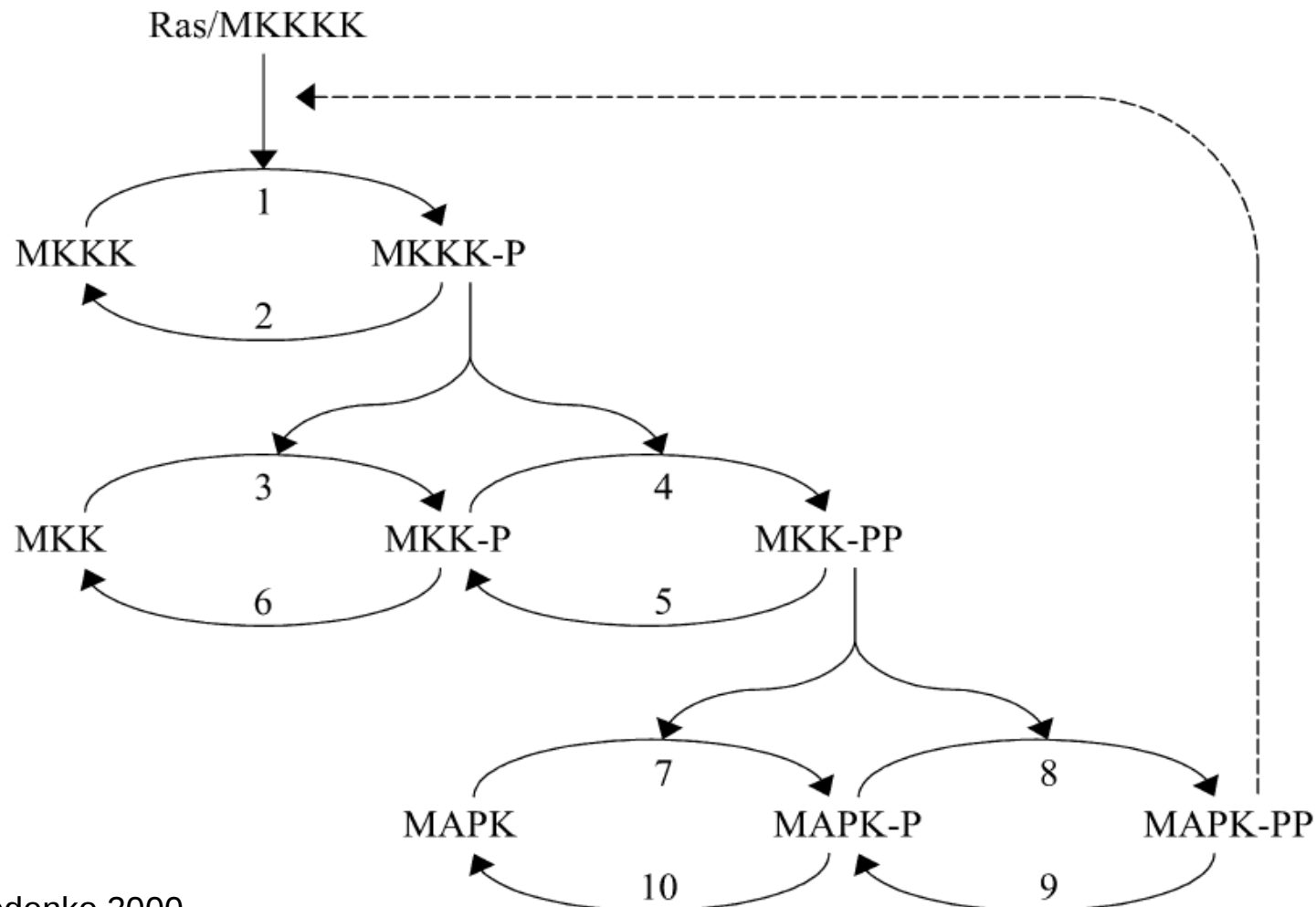

Kholodenko 2000



## Results:

- ❑ negative feedback of MAPK-PP on the activation of MAPKKK can lead to sustained oscillations of MAPK activity
- ❑ oscillatory MAPK activation has been found in various systems (eg.: Dictyostelium cAMP dependent signalling (Maeda et al 2009) and Yeast pheromone response (Hilioti et al. 2008))



Published January 26, 2004

**JCB**  
Report

## Signaling switches and bistability arising from multisite phosphorylation in protein kinase cascades

**Nick I. Markevich, Jan B. Hoek, and Boris N. Kholodenko**

Department of Pathology, Anatomy, and Cell Biology, Thomas Jefferson University, Philadelphia, PA 19107

**M**itogen-activated protein kinase (MAPK) cascades can operate as bistable switches residing in either of two different stable states. MAPK cascades are often embedded in positive feedback loops, which are considered to be a prerequisite for bistable behavior. Here we demonstrate that in the absence of any imposed feedback regulation, bistability and hysteresis can arise solely from a distributive kinetic mechanism of the two-site MAPK phosphorylation and dephosphorylation. Importantly, the reported kinetic properties of the kinase (MEK) and phosphatase

(MKP3) of extracellular signal-regulated kinase (ERK) fulfill the essential requirements for generating a bistable switch at a single MAPK cascade level. Likewise, a cycle where multisite phosphorylations are performed by different kinases, but dephosphorylation reactions are catalyzed by the same phosphatase, can also exhibit bistability and hysteresis. Hence, bistability induced by multisite covalent modification may be a widespread mechanism of the control of protein activity.



- This model focus on the final level of the MAPK cascade
- explores various different kinetic mechanisms → we concentrate on the distributive, ordered Michaelis-Menten kinetics with competitive inhibition
- concentrations and parameter values taken from estimates and experiments to be in a physiological range

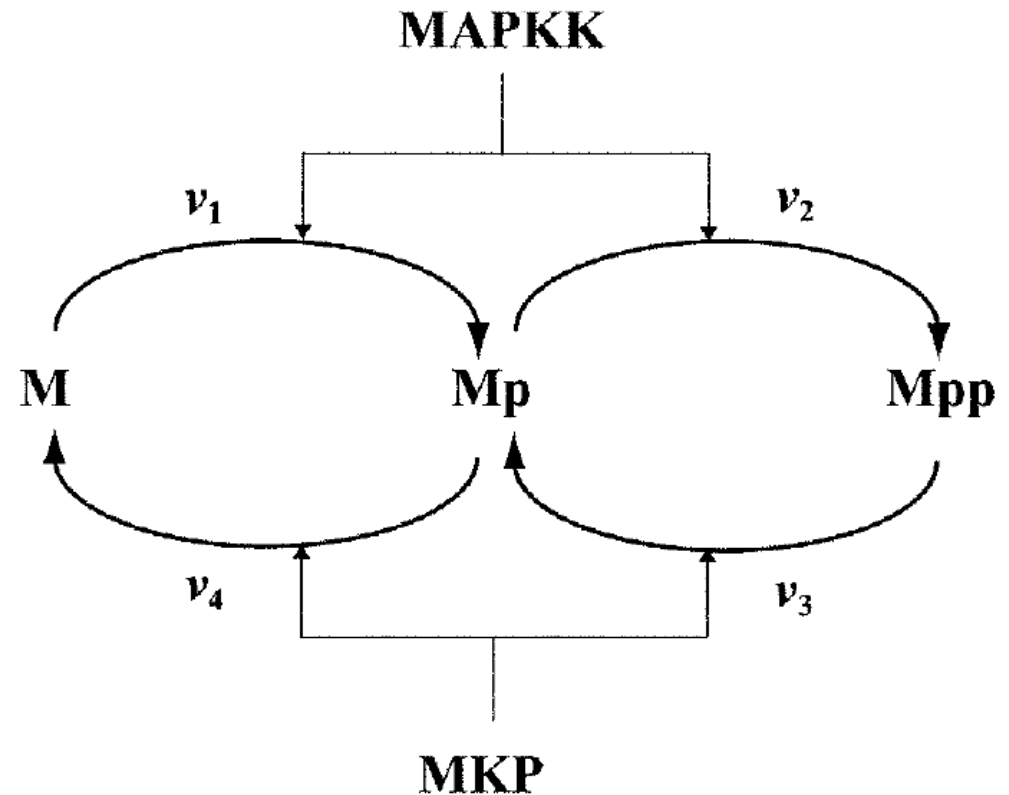

Dual phosphorylation-dephosphorylation cycle of MAPK, in which both MAPKK and MKP follow distributive ordered kinetic mechanisms. M, Mp and Mpp stand for the unphosphorylated, monophosphorylated and biphosphorylated forms of MAPK.



- over a certain region of signal, a system shows two steady states
- the system can switch state, either if the signal goes over the activation or fall under the deactivation threshold
- the system exhibits a memory effect, also known as hysteresis

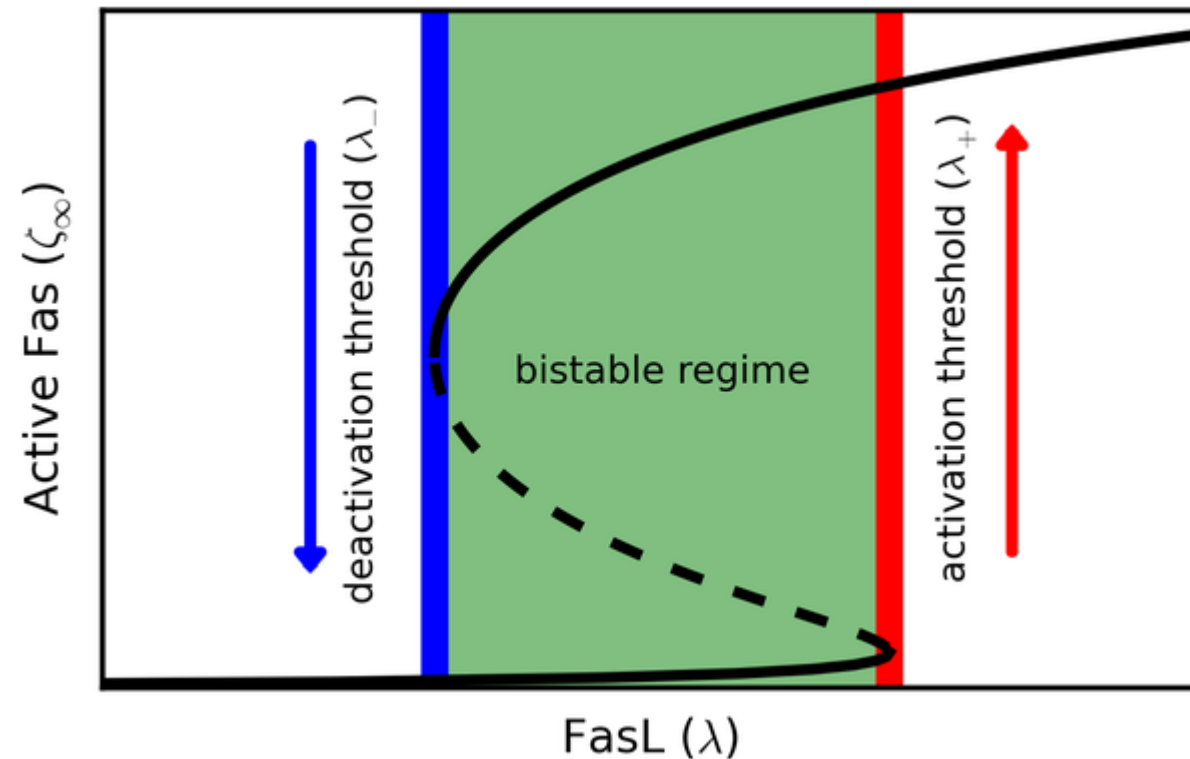

Kenneth L. Ho, Heather A. Harrington: Bistability in Apoptosis by Receptor Clustering; PLoS Comp. Biol. 2010 6(10): e1000956.



- amount of active MAP kinase (Mpp) depends on the signal (active MAPKK)
- in a certain range of signal strength, two stable activity states coexist ( $S_1$  and  $S_3$ )
- in the bistable range, the systems state depends on the history of the system – memory or hysteresis effect

